

## INSTALLING/REPLACING UNIVERSAL LIGHTPROBE™ FIBER-OPTIC PROBES

### SINGLE FIBER-OPTIC PROBES PROCEDURE:

#### 1. PROBE FULLY INSERTED AT FACTORY

Illustration shows a single Fiber-optic Probe as installed in the factory.

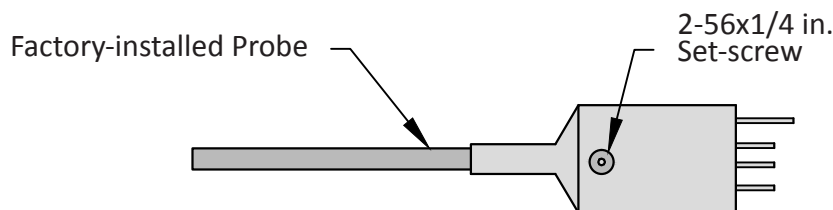

#### 2. REMOVING PROBE

By unscrewing the small set-screw 3mm (1/8th in.) the Probe can be removed.

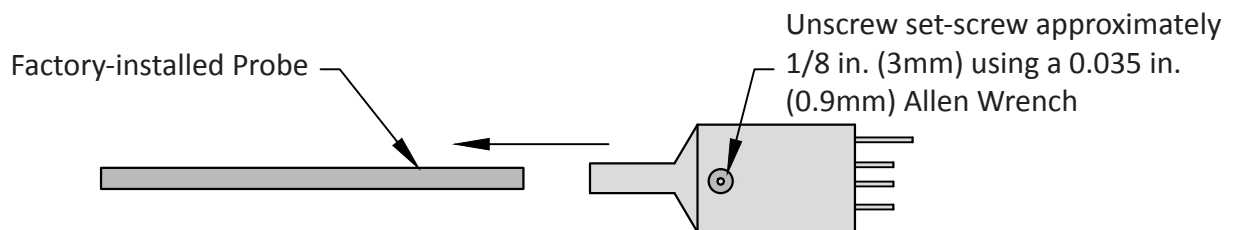

#### 3. NEW PROBE FULLY INSERTED (0.75IN/19MM)

Insert the replacement Probe as far as it will go into the Sensor, i.e. 0.75in (19mm)

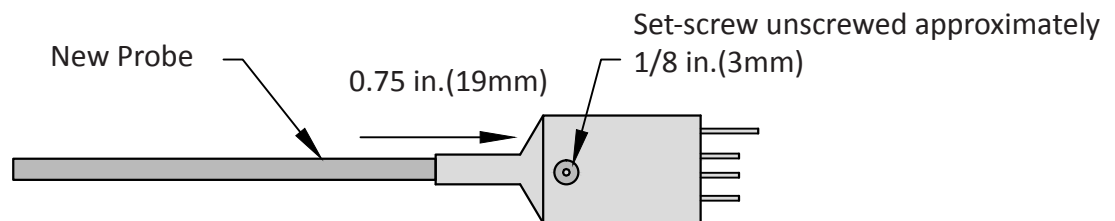

#### 4. NEW PROBE SECURED

Holding the Probe fully inserted in the Sensor, screw in the set-screw until tight, but **DO NOT OVER-TIGHTEN**.

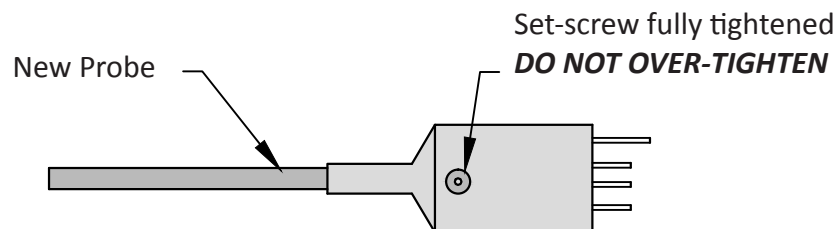

**Continued:**

## INSTALLING/REPLACING UNIVERSAL LIGHTPROBE™ FIBER-OPTIC PROBES

### DUPLEX FIBER-OPTIC PROBE PROCEDURE:

#### 1. REMOVING OLD/BROKEN PROBES

Unscrew the small set-screw 1/8<sup>th</sup> inch (3mm) and remove the Probes.

Unscrew set-screw  
 1/8 in. using 0.035 in.  
 (0.9mm) Allen Wrench

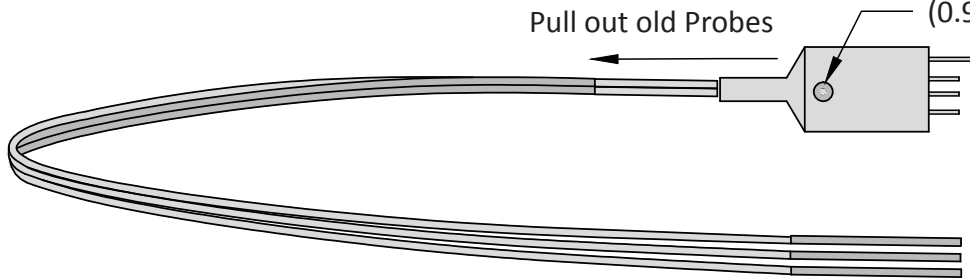

#### 2. PREPARING NEW PROBES

Grip the two or three new Probes at the shortest stainless-steel tips (1.24in./28mm). First, align the ends on a clean sheet of paper and then insert them into the Sensor as far as they will go, i.e. 0.75in. (19mm). Check that each Probe cannot be pushed in any further.

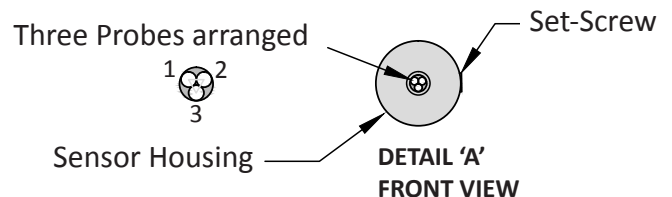
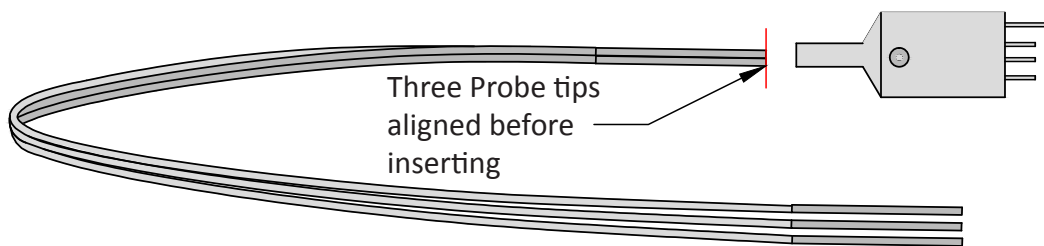

#### 3. INSERTING NEW PROBES

Holding the Probes fully inserted in the Sensor, screw in the set-screws until just tight.  
**DO NOT OVER TIGHTEN.**

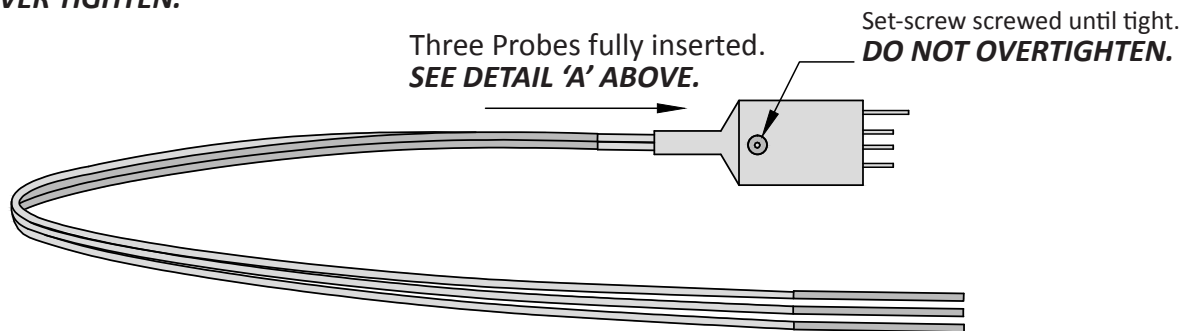

## INSTALLING/REPLACING UNIVERSAL LIGHTPROBE™ FIBER-OPTIC PROBES

### DUPLEX FIBER-OPTIC PROBE PROCEDURE:

#### 1. REMOVING OLD/BROKEN PROBES

Unscrew the small set-screw 1/8<sup>th</sup> inch (3mm) and remove the Probes and Dowel Pin.

Unscrew set-screw  
1/8 in. using 0.035 in.  
(0.9mm) Allen Wrench

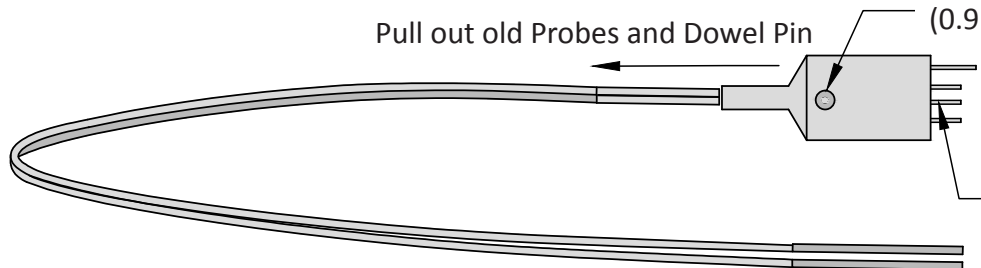

#### 2. PREPARING NEW PROBES

Grip the two new Probes at the shortest stainless-steel tips (1.24in./28mm) with the Dowel Pin (P/N SSDP). First, align the ends on a clean sheet of paper and then insert them into the Sensor as far as they will go, i.e. 0.75in.(19mm). Check that each Probe and the Dowel pin cannot be pushed in any further.

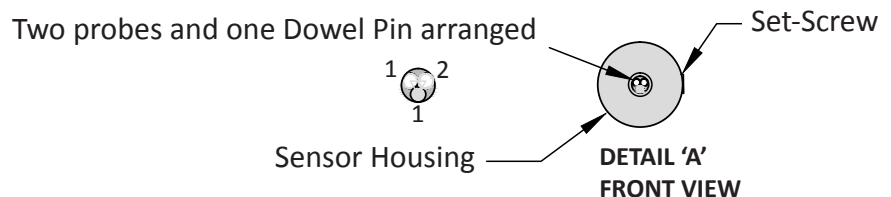
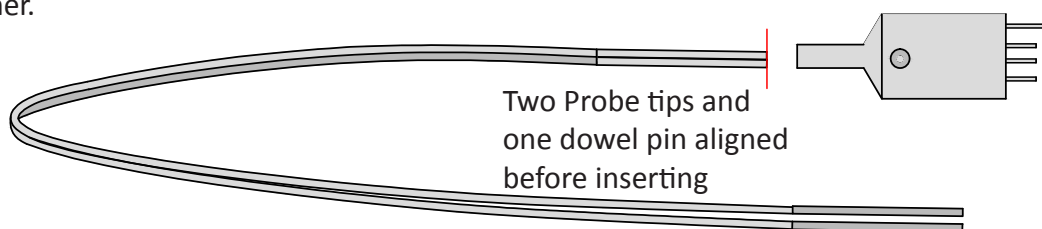

#### 3. INSERTING NEW PROBES

Holding the Probes and Dowel Pin fully inserted in the Sensor, screw in the set-screws until just tight.  
**DO NOT OVER TIGHTEN.**

Three probes fully inserted.  
**SEE DETAIL 'A' ABOVE.**

Set-screw screwed until tight.  
**DO NOT OVERTIGHTEN.**

